

35⁵

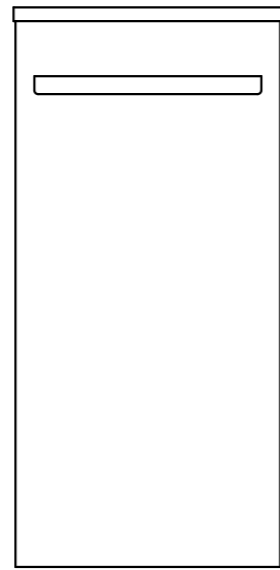

18

72²

74

35

30⁵

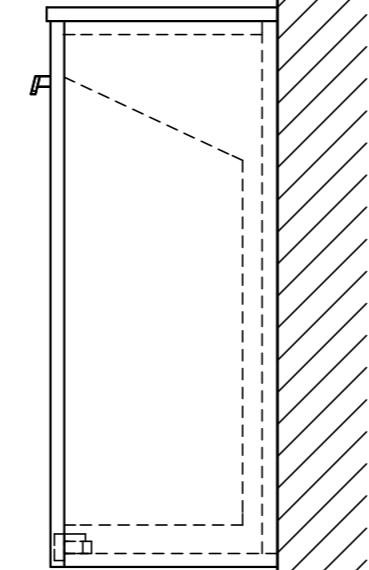

18

28²

30