

35⁵

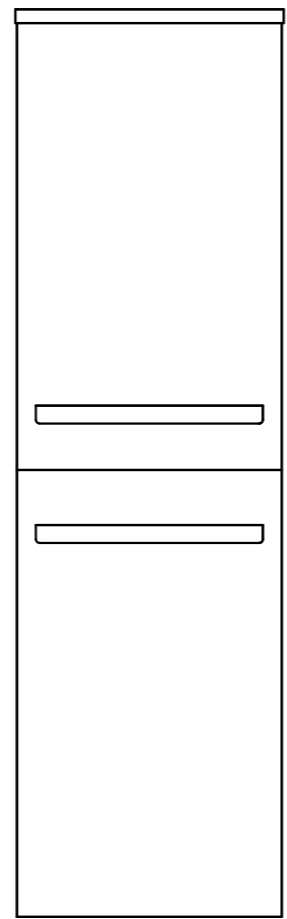

18

118²

120

35

30⁵

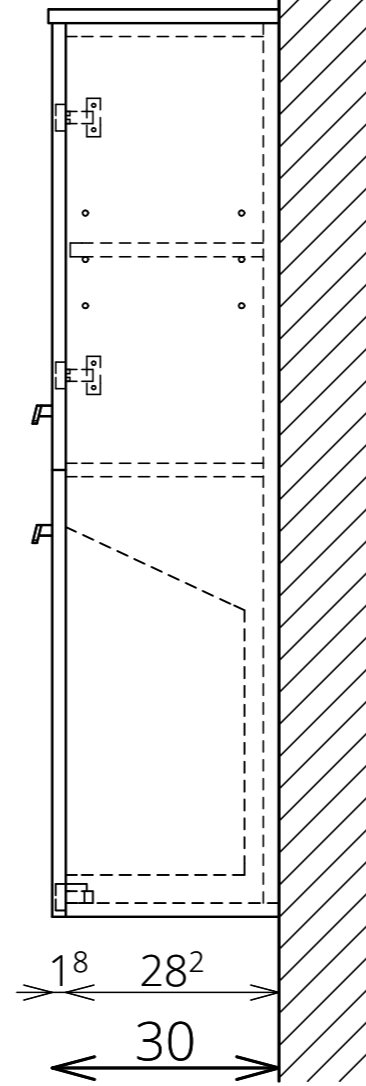

18

28²

30